



Process for Accuracy

Tuning your HP MJF to the design

Introduction

There are several recommendations that must be evaluated during the printing process to maximize accuracy.

Optimizing dimensional accuracy

To maximize accuracy, the system needs to operate at voxel level with adequate energy delivered to properly fuse the intended sections layer by layer. To achieve this, it is recommended to bear the following in mind:

Printing profiles and materials

- In general, Balanced print profiles are recommended for optimizing dimensional accuracy. Fast modes (HP 3D HR PA 11 ["HP PA 11"] and HP 3D HR PA 12 ["HP PA 12"]) can be considered lower-cost alternatives, keeping in mind their associated mechanical trade-off.
- In the case of HP PA 11, it is also better to use the Balanced print profile, which is dimensionally similar to HP PA 12 on the XY-plane but has a higher trade-off with respect to the Z-axis.
- When warpage is the main concern, it is recommended to switch from Balanced (HP PA 11) to Fast (HP PA 11).
- With thin and long parts where flatness is critical, consider using HP PA 12 or HP 3D HR PA 12 Glass Beads ("HP PA 12 GB"), since HP PA 11 presents higher warpage potential. If HP PA 11 is the material of choice, then it is recommended to use the Fast print profile.

Build platform placement and printing process

- Orient each part by placing its critical features on the horizontal XY-plane as this will provide the highest resolution.
- Place small features such as pins, holes, and thin walls upside-down on the XY-plane to improve their look, feel, and strength. This also applies to raised texts, which should be printed on the XY-plane for maximum resolution.
- Embossed text, however, results in increased clarity when printed facing upwards.



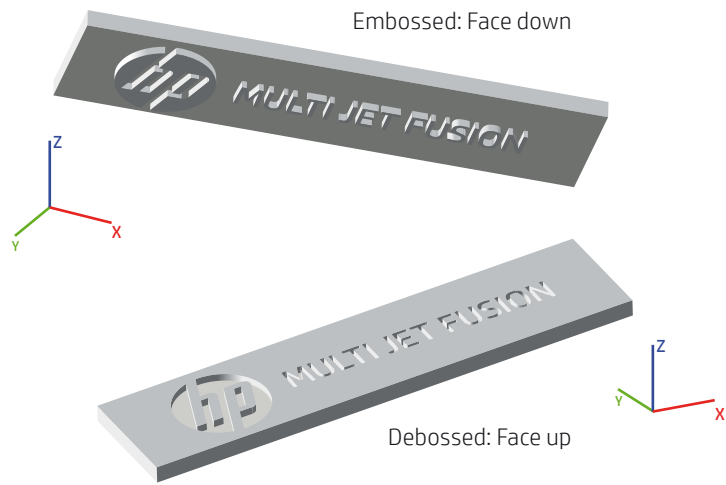

Figure 1. Recommended orientations for embossed (face down) and debossed (face up) text on HP Multi Jet Fusion parts

- The recommended minimum distance between parts is 5 mm, and the ideal distance between parts and the build volume margins is between 10 mm and 20 mm.
- It is recommended to leave enough space between dense parts, or those with a wall thickness greater than 15 mm. This distance should be more than 10 mm.

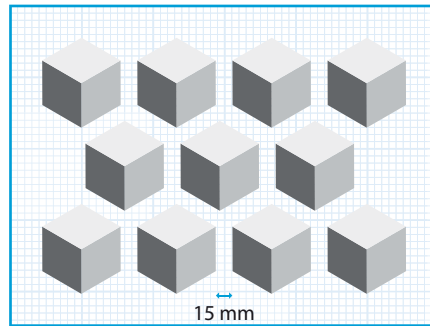

Figure 2. Recommended distance between dense parts

- It is recommended to place the parts with the highest dimensional requirements, especially on the Z-axis, as centered and as low on the printing platform as possible.
- It is recommended to distribute the parts as homogeneously as possible on the XY-plane to facilitate similar energy absorption across the printing bed.

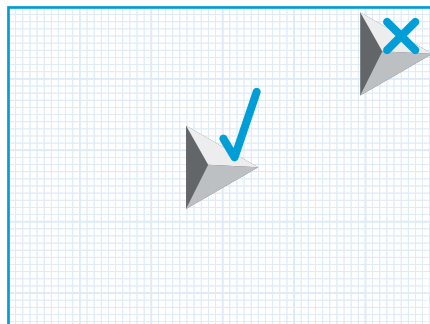

Figure 3. Recommended parts placement

- As well as in the XY-plane, it is recommended to place the parts in the bucket to prevent drastic changes in the printed areas per layer in the Z-direction.



Information about the printed area distribution is provided by some professional suites like Materialise Magics.

- A good compromise between throughput and part quality is a packing density range between 8% and 12%. However, this value can be revisited depending on application requirements.

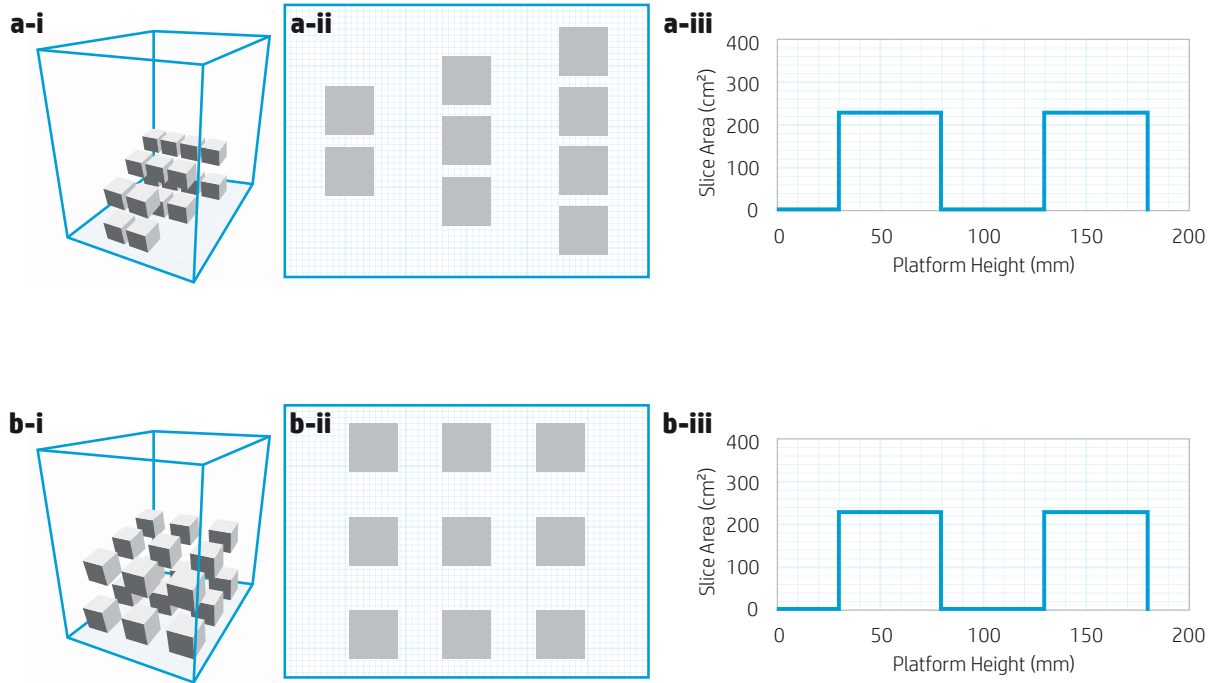

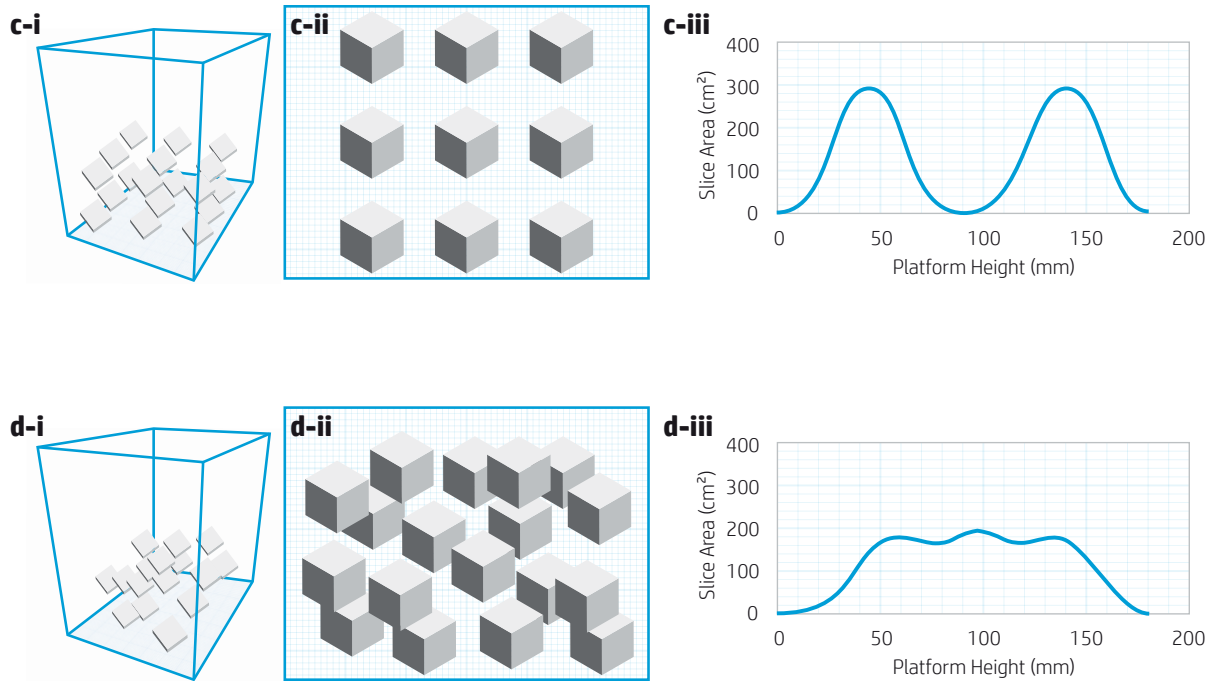

Figure 4. The printed area per layer distribution (right column) is used as an indicator of homogeneity in the Z-direction to prevent big differences in the energy absorption of parts. a) An example of a non-recommended job configuration displaying non-homogeneity in the three dimensions. b) A job that is homogeneous on the XY-plane but with a distinct and potentially problematic gap along the Z-axis. c) The gap along the Z-axis is smoother after rotating the cubes in order to prevent exposing large areas to the last layers to be printed. d) Using automatic packing, the printed area distribution is smoothed even further, minimizing adverse thermal effects. This is a recommended configuration.

Warpage concern

- When warpage is the main concern—especially for large, thin, flat parts—it is recommended to place the parts parallel to the XY-plane.
- Long parts should be placed along the Y-axis to reduce the thermal gradient even further, as this is the printing direction of the carriage.
- When printing parts prone to warpage, it is recommended to place them as centered and as low on the platform as possible. This allows them to cool more slowly, reducing the probability of warpage.
- It is recommended to print short jobs in order to minimize the Z-height—number of layers—which allows for faster printing and cooling stages.
- It is recommended to avoid fast cooling for parts prone to warpage.

Keep in mind that thin polyamide parts are not very stiff, which means that most warped parts can be effortlessly re-shaped once they are mounted in their designated place.



Thermal post-treatments can be applied to conform the material into a different shape after printing, allowing for fine-tuning of finished parts.

Dense parts

Dense parts are those with a substantial mass concentrated in a reduced volume, thus resulting in fewer cavities and walls no thicker than 15 mm to 20 mm.

- Favorable orientation is critical for parts that do not have a homogeneously distributed mass. It is recommended to print them at an angle and not along clear array patterns in order to facilitate heat distribution during printing.
- Make sure that the parts are appropriately separated (> 10-15 mm) and that the packing density does not go beyond the recommended range.



To decrease packing density, reduce the mass of the objects by hollowing them or adding internal lattices structures.

- High packing density print jobs with dense parts may result in powder deterioration and eventually impact the powder recyclability and, thus, the cost.

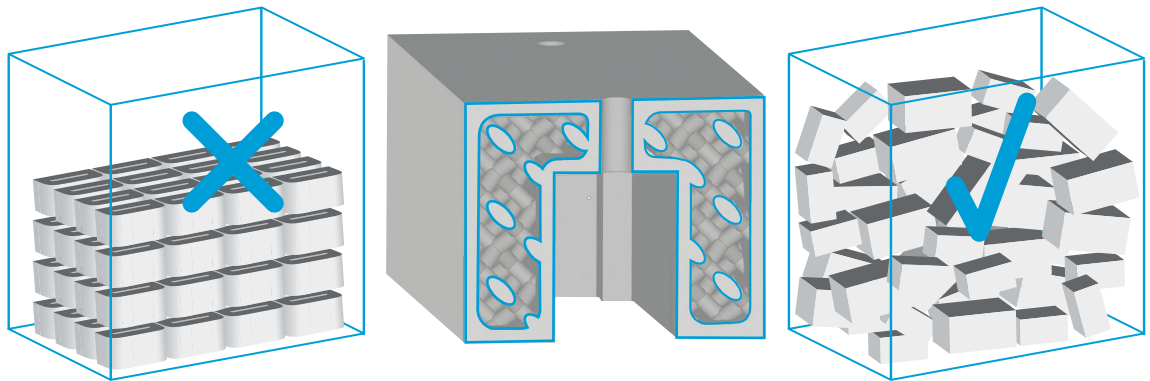

Figure 5. Left: This print job design is not recommended due to excessive packing density, dense parts, array configuration, and flat orientation. Middle: Section of a dense part that has been lightened by applying internal lattices. Right: Recommended print job configuration with lightened parts and increased part separation, tilted orientation, and more degrees of freedom during automatic packing

The recommendations are summarized in the following flowchart, which can be used as a guide for maximizing the dimensional accuracy of HP MJF–printed parts:

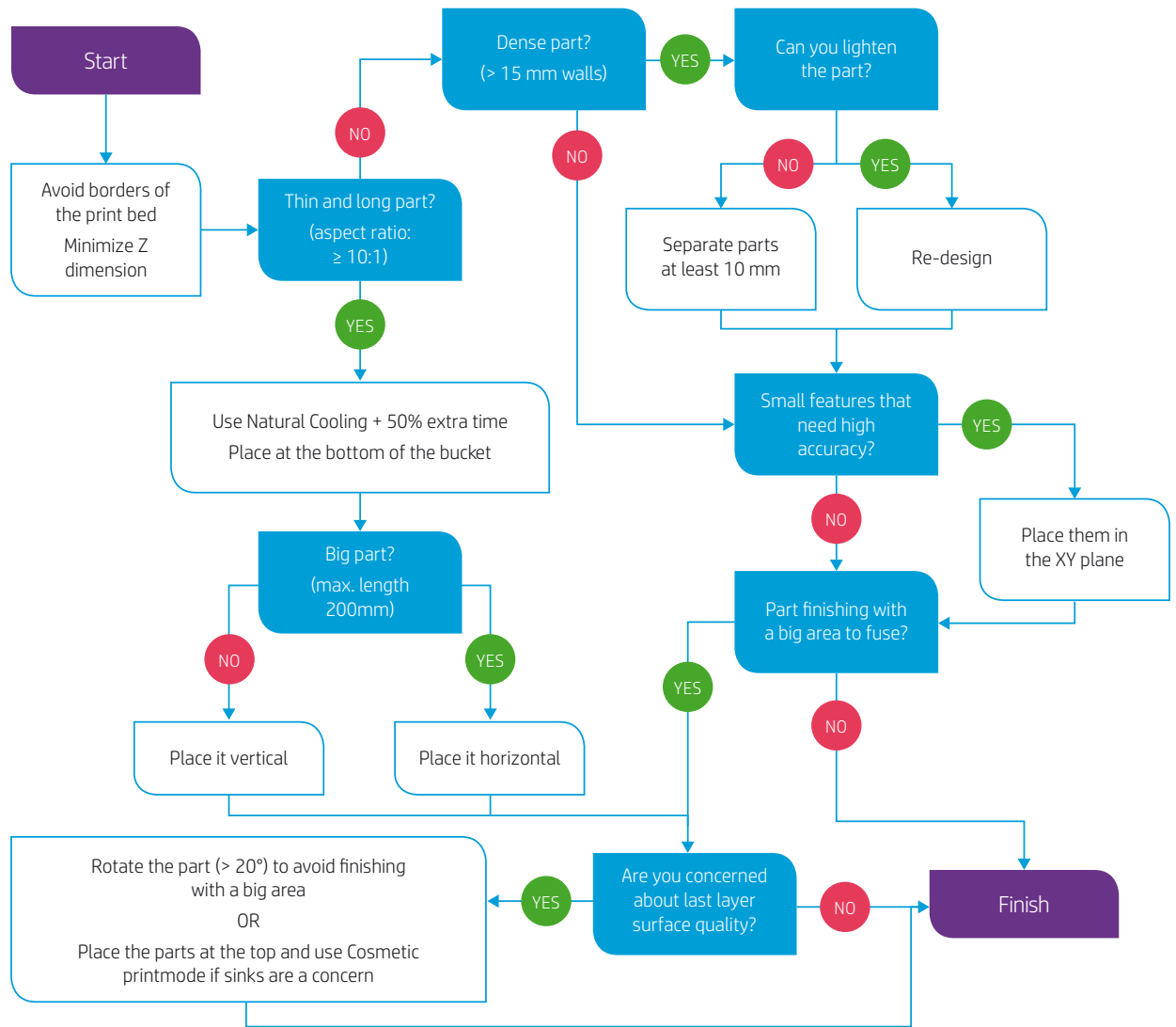

Figure 6. Dimensional accuracy flowchart

Dimensional accuracy examples

Honeycomb plate

The following example involves the printing of a honeycomb plate to maximize dimensional accuracy. This part is very similar to a big, flat plane, and therefore the object is moderately susceptible to experience warpage. However, thanks to its light honeycomb design, this deformation is not expected to be as severe as on a fully dense plate.

To maximize the accuracy and circularity of positioning holes, it is recommended to orient the part so that these features are contained on the XY-plane. This orientation minimizes the height of the part, which is compatible with the recommendations for reducing warpage and bowing.

To preserve the flatness of a part, center it as much as possible on the platform, place it in the lowest quarter, and use Slow Cooling (50% longer than the standard recommendation).

Keep in mind that placing a part flat can induce capillarity on its top face, so angle the part slightly to prevent it if this is more critical than obtaining maximum accuracy of its holes. This trade-off is reduced for HP PA 12 GB and HP PA 11 parts in Fast and Balanced print profiles, which result in similar accuracies with reduced capillarity and abraded tops.

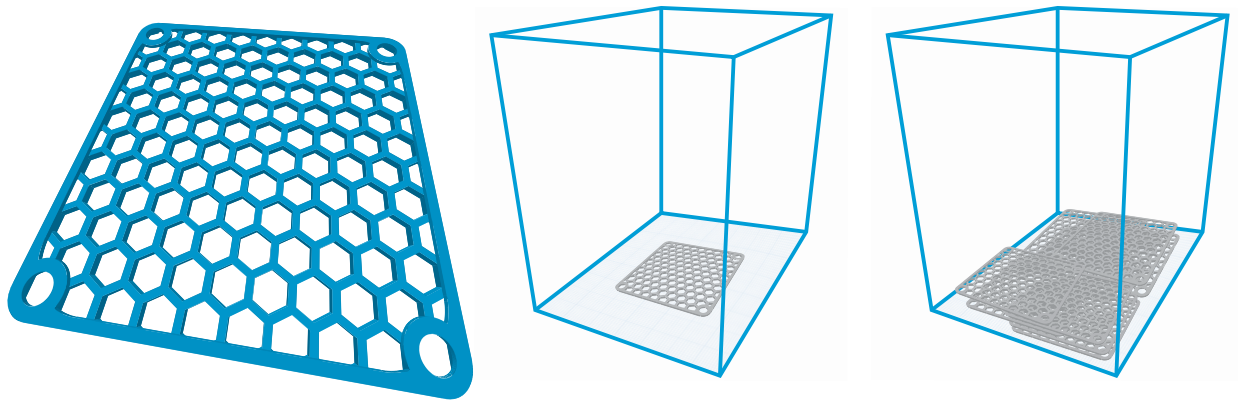

Figure 7. A honeycomb plate (left) oriented to maximize dimensional accuracy and minimize warpage. Critical features such as the positioning holes are contained on the XY-plane (middle). Right: A bucket with 10 plates in the same orientation

As shown in the figure above, in a collective scenario where several plates of this type are required, the following are recommended:

- Print short buckets (using different Build Units).
- Center the parts as much as possible.
- Make sure that a similar number of parts are being printed at each level. In the example there are either two parts or none.
- Shuffle the parts so that they do not line up along the same XY-coordinates. This allows the printing load to be shared across more printheads, extending their lifespans.
- Use extended Natural Cooling.

Phone case

The following example involves a phone case that does not require a great deal of accuracy but can potentially show warpage and bowing if not correctly oriented. This is a flat and thin part that can be considered small, and it is a good candidate for orienting perpendicularly to the XY-plane, laying on its side parallel to the Y-axis.

In this orientation, each layer is printed very quickly while the height is still short enough for the build to maintain thermal homogeneity. To minimize warpage the parts must be placed as centrally as possible, jobs should be short, and Fast Cooling should be avoided.

However, these recommendations apply mainly to HP PA 12, HP PA 12 GB, and the Fast print profile of HP PA 11, as these configurations are not significantly affected by the bowing effect if parts are printed far from the walls.

Mechanical and Balanced modes for HP PA 11 can exhibit incidences of bowing, so it is worth considering an alternative orientation. In these cases, this part should be placed flat on the XY-plane as is the case for bigger objects. The rest of the guidelines, such as using extended Natural Cooling and printing short jobs, still apply.

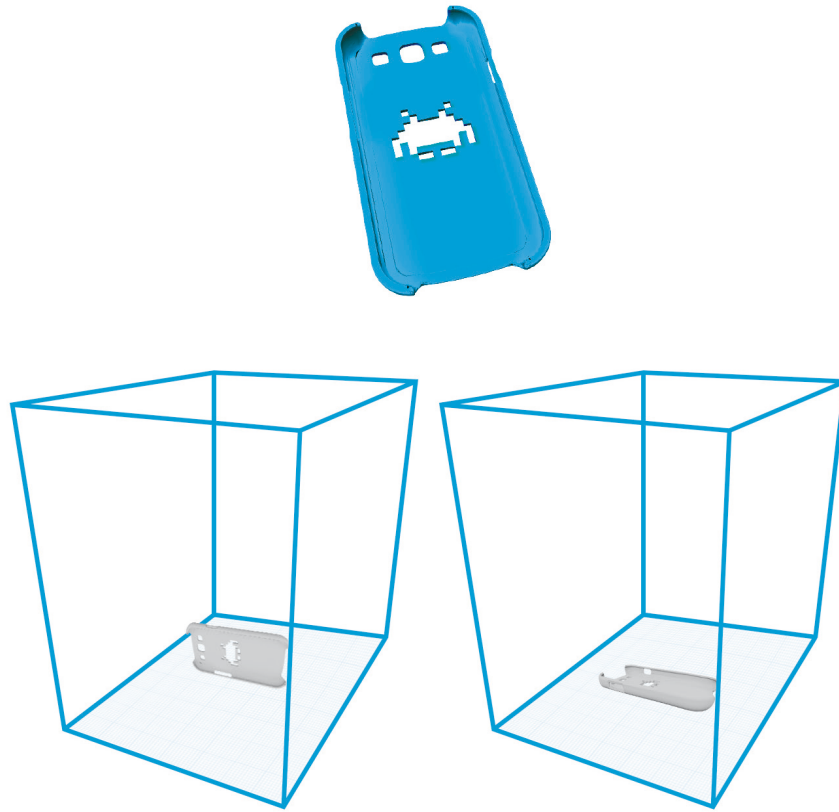

Figure 8. Left: A phone case to be printed. Middle: The suggested orientation for minimizing warpage when there is a low probability of bowing. Right: An alternative orientation that minimizes the bowing effect while still being a good option for reducing warpage